

EnGenius®

**High Output Power
802.11 b/g/n Multi-function Access Point**



EAP300

802.11 N Multi-Function Access Point

V1.0

Table of Contents

1	Introduction	4
1.1	Features and Benefits	4
1.2	Package Contents	5
1.3	System Requirements.....	6
1.4	Applications	6
2	Before you Begin	8
2.1	Considerations for Wireless Installation	8
2.2	Computer Settings (Windows XP/Windows 7).....	9
2.3	Apple Mac X OS.....	12
2.4	Hardware Installation.....	13
3	Configuring Your Access Point	14
3.1	Default Settings	14
3.2	Web Configuration.....	15
4	System	18
4.1	Operation Mode.....	18
4.2	Status.....	20
4.3	DHCP	22
4.4	Schedule.....	24
4.5	Event Log	26
4.6	Monitor.....	27
5	Wireless	28
5.1	Status.....	28
5.2	Basic.....	29

5.3	Advanced	31
5.4	Security	35
5.5	Filter	41
5.6	WPS (Wi-Fi Protected Setup)	43
5.7	Client List.....	45
5.8	VLAN.....	46
6	Network.....	47
6.1	Status.....	47
6.2	LAN.....	48
6.3	Spanning Tree	50
7	Management.....	51
7.1	Admin.....	51
7.2	SNMP.....	52
7.3	Firmware Upgrade.....	54
7.4	Configure	57
7.5	Reset.....	58
8	Tools.....	59
8.1	Time Setting.....	59
8.2	Diagnosis.....	60
8.3	LED Control	61
9	Logout	62
	Appendix A – FCC Interference Statement	63

Revision History

Version	Date	Notes
1.0	Sep. 12, 2011	First Release

1 Introduction

The **EAP300** is a multi-functioned 802.11b/g/n product with 3 major functions. It is designed to operate in every working environment for enterprises.

The EAP300 is a Wireless Network device that delivers up to 6x faster speeds and 7x extended coverage than 802.11b/g devices. The EAP300 supports use in the home network with superior throughput, performance, and unparalleled wireless range.

To protect data during wireless transmissions, the EAP300 encrypts all wireless transmissions through WEP data encryption and supports WPA/WPA2 encryption. Its MAC address filter allows users to select stations to access the network. The EAP300 is an ideal product to ensure network safety for both home and enterprise environments.

1.1 Features and Benefits

Features	Benefits
High Speed Data Rate Up to 300Mbps	Capable of handling heavy data payloads such as HD multimedia streaming.
10/100 Fast Ethernet	Supports up to 100Mbps networking speed.
IEEE 802.11n draft Compliant and backward compatible with 802.11b/g	Fully compatible with IEEE 802.11b/g/n devices.
Multi-Functional	Allows users to select AP, WDS AP, or WDS Bridge mode in various applications.
Point-to-Point or Point-to-Multipoint Wireless Connectivity	Allows transfer of data from building to building.

Support Multiple SSID (up to 4) in AP mode	Allows clients to access different networks through a single access point and assign different policies and functions for each SSID through the built in software.
WPA/WPA1/IEEE 802.1x support	Powerful data security.
MAC Address filtering (AP mode)	Ensures secure network connections.
User isolation support (AP mode)	Protects the private network between client users.
Power-over-Ethernet (IEEE802.3af)	Flexible Access Point locations and saving cost.
Save User Settings	Firmware upgrade does not delete user settings.
SNMP Remote Configuration Management	Allows remote connection to configure or manage the EAP300 easily.
QoS (WMM) support	Enhanced user performance and density.

1.2 Package Contents

The EAP300 package contains the following items (all items must be in package to issue a refund):

- EAP300
- 12V/1A 100V~240V Power Adapter
- RJ-45 Ethernet LAN Cable
- CD-ROM with User Manual
- Quick Guide

1.3 System Requirements

The following are the minimum system requirements in order to configure the device.

- Computer with an Ethernet interface or Wireless Network.
- Windows, Mac OS, or Linux based operating systems.
- Web-Browsing Application (example: Internet Explorer, FireFox, Safari, or other similar software)

1.4 Applications

Access Point products are easy to install and highly efficient. The following list describes some of the many applications made possible through the power and flexibility of the use of Wireless Access Points:

a) **Difficult-to-Wire Environments**

There are many situations where wires cannot be laid easily. Historic buildings, older buildings, multiple buildings, and/or open areas make the installation of a Wired LAN impossible, impractical, and/or expensive.

b) **Temporary Workgroups**

Consider situations in open areas such as parks, athletic arenas, exhibition centers, temporary offices, and construction sites where one wants a temporary Wireless LAN established and easily removed.

c) **The Ability to Access Real-Time Information**

Doctors/Nurses, Point-of-Sale Employees, and/or Warehouse Workers can access real-time information while dealing with patients, serving customers, and/or processing information.

d) **Frequently changed environments**

Show rooms, meeting rooms, retail stores, and manufacturing sites where the network connection needs to frequently be taken down.

e) Small Office and Home Office (SOHO) Networks

SOHO users need a cost-effective, easy and quick installation of a small network.

f) Wireless Extensions to Ethernet networks

Network managers in dynamic environments can minimize the overhead caused by moves, extensions to networks, and other changes with wireless LANs.

g) Wired LAN backup

Network managers implement wireless LANs to provide backup for mission-critical applications running on wired networks.

h) Training/Educational facilities

Training sites at corporations and students at universities use wireless connectivity to ease access to information, information exchanges, and learning.

2 Before you Begin

This section will guide you through the installation process. Placement of the ENGENIUS EAP300 is very important to maximize the EAP300's performance. Avoid placing the EAP300 in an enclosed space such as a closet, cabinet, or wardrobe.

2.1 Considerations for Wireless Installation

The operating distance of all wireless devices cannot be pre-determined due to a number of unknown obstacles in the environment that the device is deployed in. These could be the number, thickness, and location of walls, ceilings, or other objects that the wireless signals must pass through. Here are some key guidelines to ensure that you have the most optimal wireless range.

- Keep the number of walls and/or ceilings between the EAP300 and other network devices to a minimum. Each wall and/or ceiling can reduce the signal strength, resulting in lower signal strength.
- Building materials makes a difference. A solid metal door and/or aluminum studs may have a significant negative effect on the signal strength of the EAP300. Locate your wireless devices carefully so the signal can pass through a drywall and/or open doorways. Materials such as glass, steel, metal, concrete, water (example: fish tanks), mirrors, file cabinets, and/or brick can also lower your wireless signal strength.
- Interferences can also come from other electrical devices and/or appliances that generate RF noise. The most usual types are microwaves and cordless phones.

2.2 Computer Settings (Windows XP/Windows Vista/Windows 7)

In order to use the EAP300, you must first configure the TCP/IPv4 connection of your computer system.

- Click **Start** button and select **Control Panel**.



Windows XP

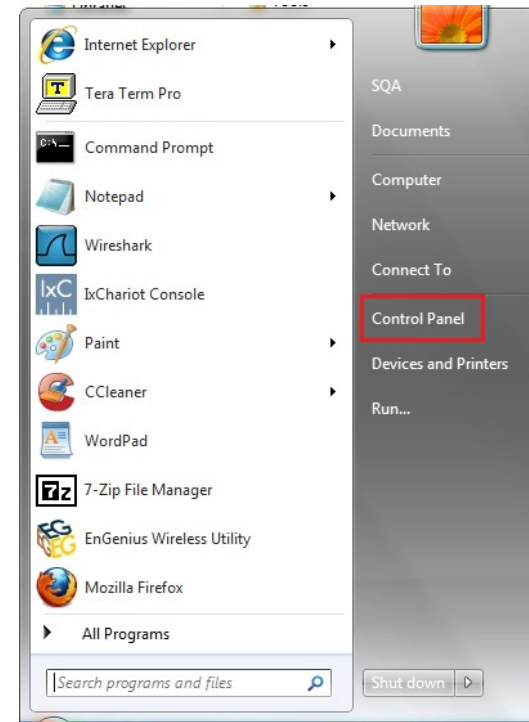

Windows Vista/Windows 7



- In **Windows XP**, click **Network Connections**

- In **Windows 7**, click **View Network Status and Tasks** in the **Network and Internet** section, then select **Change Adapter Settings**



- Right click on **Local Area Connection** and select **Properties**

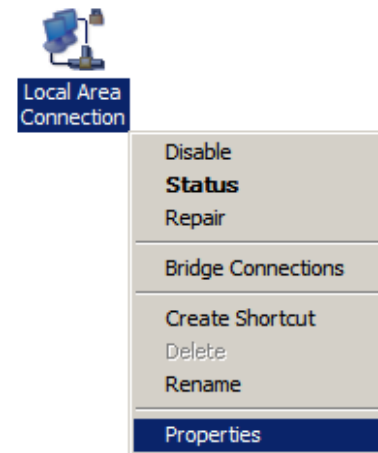

- Highlight **Internet Protocol Version 4 (TCP/IPv4)** and select **Properties**

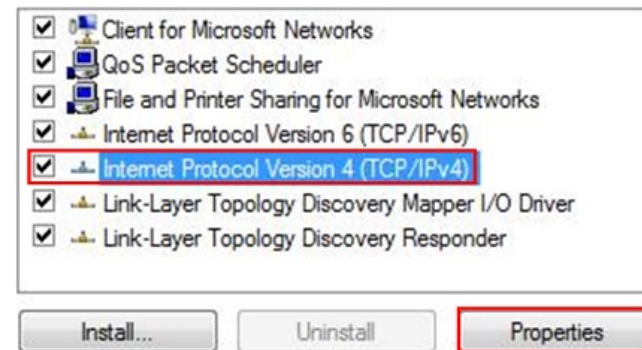

- Select **Use the following IP address** and enter IP address and subnet mask then press **OK**.

Note: Ensure that the IP address and subnet mask are on the same subnet as the device.

For example: Device IP address: 192.168.1.1
 PC IP address: 192.168.1.2 - 192.168.1.999
 PC subnet mask: 255.255.255.0

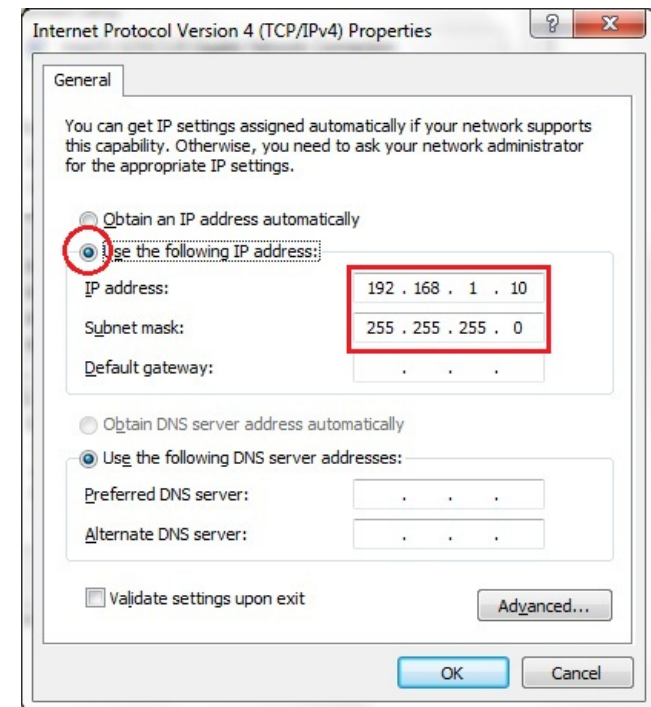

2.3 Apple Mac X OS

- Open the **System Preferences** (can be opened in the **Applications** folder or selecting it in the Apple Menu)
- Select **Network** in the **Internet & Network** section
- Highlight **Ethernet**
- In **Configure IPv4**, select **Manually**
- Enter IP address and subnet mask then press **OK**.

Note: Ensure that the IP address and subnet mask are on the same subnet as the device.

For example: Device IP address: 192.168.1.1
 PC IP address: 192.168.1.2 - 192.168.1.999
 PC subnet mask: 255.255.255.0

- Click **Apply** when done.

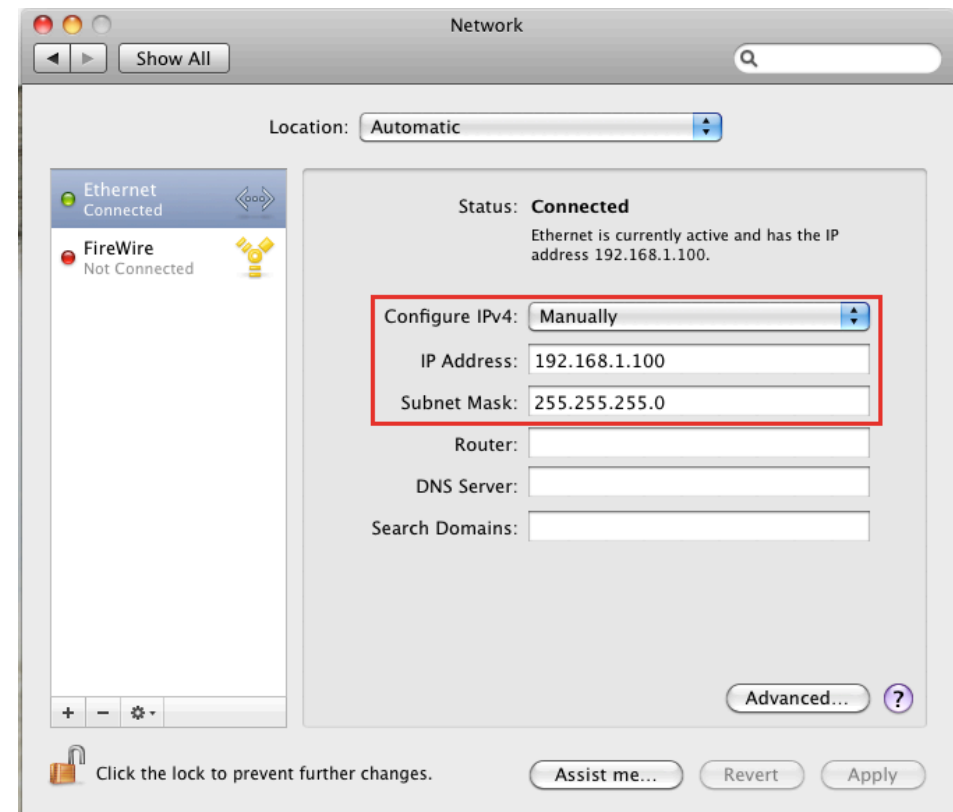

2.4 Hardware Installation

- 1) Ensure that the computer in use has an Ethernet Card (RJ-45 Ethernet Port). For more information, verify with our computer user manual.
- 2) Connect one end of the Category 5 Ethernet cable into RJ-45 port of the EAP300 and the other end to the RJ-45 port on the computer that will use the EAP300. Ensure that the cable is securely connected to both the EAP300 and the Computer.
- 3) Connect the Power Adaptor DC Inlet to the **DC-IN** port of the EAP300 and the Power Adaptor to the electrical out. Once both connections are secure, verify the following:
 - a) Ensure that the **Power** light is on (it will be blue).
 - b) Ensure that the **Wireless** light is on (it will be blue).
 - c) Ensure that the **LAN (Computer/EAP300 Connection)** light is on (it will be blue).
 - d) Once all three lights are on, proceed to setting up the computer.

This diagram depicts the hardware configuration.

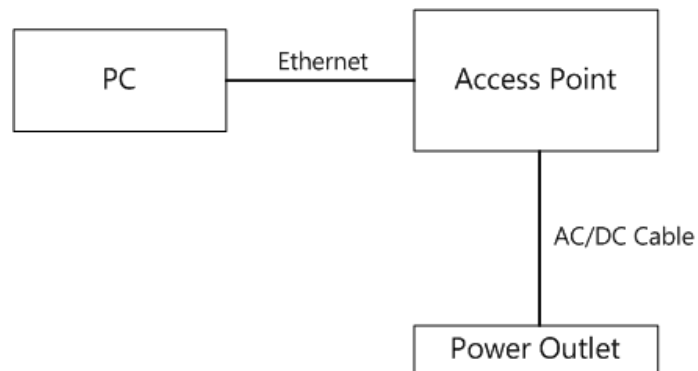

3 Configuring Your Access Point

This section will show you how to configure the device using the web-based configuration interface.

3.1 Default Settings

Please use your Ethernet port or wireless network adapter to connect the Access Point.

Default Settings

IP Address	192.168.1.1
Username / Password	admin / admin
Operation Mode	Access Point
Wireless SSID	EnGeniusxxxxxx
Wireless Security	None

Note: xxxxxx represented in the wireless SSID above is the last 6 characters of your device MAC Address. This can be found on the device body label and is unique for each device.

3.2 Web Configuration

- Open a web browser (Internet Explorer/Firefox/Safari) and enter the IP Address: **http://192.168.1.1**

Note: If you have changed the default LAN IP Address of the Access Point, ensure you enter the correct IP Address.



- The default username and password are **admin**. Once you have entered the correct username and password, click the **Login** button to open the web-base configuration page.

A screenshot of the EnGenius login form. The form is titled "EnGenius" and contains two input fields: "Username:" with the value "admin" and "Password:" with five dots. Below the fields are two buttons: "Login" and "Cancel".

EnGenius

Username:

Password:

- If successful, you will see the EAP300 User Menu



2.4GHz Wireless-N Multi-function AP

Access Point Mode

- System
- Wireless
- Network
- Management
- Tools
- Logout

You can use the Status page to monitor the connection status for WLAN/LAN interfaces, firmware and hardware version numbers.

System	
Operation Mode	Access Point
System Time	2009/01/01 00:05:43
System Up Time	5 min 49 sec
Hardware Version	1.0.0
Serial Number	000000001
Kernel Version	1.0.0
Application Version	1.0.0

WLAN Settings	
Channel	11

SSID_1	
ESSID	EnGeniusCC3004
Security	Disable
BSSID	00:AA:BB:CC:30:04

- The navigation drop-down menu on left is divided into seven main sections:
 1. **System:** This menu includes the **Operation Mode, Status, DHCP, Schedule, Event Log,** and **Monitor.**
 2. **Wireless:** This menu includes **Status, Basic, Advanced, Security, Filter, Client List,** and **VLAN.**
 3. **Network:** This menu includes **Status, LAN,** and **Spanning Tree.**
 4. **Management:** This menu includes the **Admin, SNMP, Firmware, Configure,** and **Reset.**
 5. **Tools:** This menu includes **Time Zone, Diagnostics,** and **LED Control.**
 6. **Logout:** Used to logout of the EAP300 User Interface. To login, user must open a new browser window.

4 System

4.1 Operation Mode

Each operating mode offers different features. In order to switch the operating mode, select it from the **Operation Mode** from the **System Menu**. There are three operation modes: **Access Point**, **WDS AP**, and **WDS Bridge**.

- **Access Point:** Allow devices to connect to the **EAP300** through a simple wireless connection.
- **WDS AP (Wireless Distribution Systems Access Point):** Interconnect access points to allow wireless communication wireless devices and access points among them.
- **WDS Bridge (Wireless Distribution Systems Bridge):** Interconnect access points to allow communication between access points only.



A dialog box will appear to notify you that the system will restart in order for the changes to take effect. Click on the **OK** button to continue.

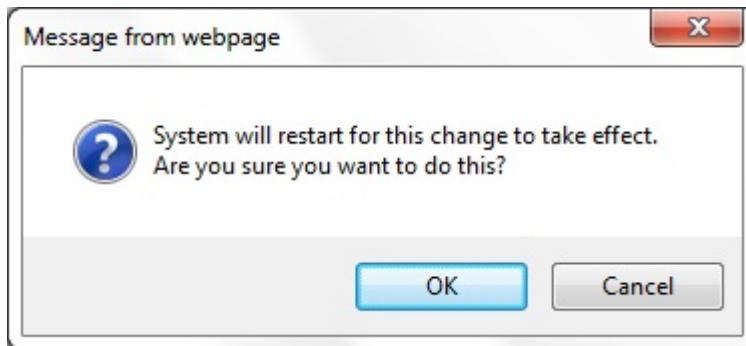

The EAP300 will display how much time it will take to restart the device in the new operating mode as shown below.

System mode is changed and module is reloading, please wait seconds.

4.2 Status

This page will display status of the device.

System

Operation Mode Access Point
 System Time 2009/01/01 00:05:43
 System Up Time 5 min 49 sec
 Hardware Version 1.0.0
 Serial Number 000000001
 Kernel Version 1.0.0
 Application Version 1.0.0

System	
Operation Mode	Displays the current mode of operation of the EAP300.
System Time	Displays the current time of the EAP300.
System Up Time	The elapsed time of operation of the EAP300.
Hardware Version and Serial Number	Hardware information of the EAP300.
Kernel and Application Version	The current firmware version of the EAP300.

WLAN Settings

Channel 11

SSID_1

ESSID EnGeniusCC3004

Security Disable

BSSID 00:AA:BB:CC:30:04

WLAN Settings	
Channel	Displays the current Wireless Channel in use by the EAP300.
ESSID	The SSID (Network Name) of the wireless network (up to 4 SSIDs supported).
Security	Current wireless encryption for the corresponding SSID.
BSSID	The MAC address of the corresponding SSID.

4.3 DHCP

The **DHCP** option in the **System** menu displays the client IP address assigned by the DHCP Server. You can also set the IP Addresses of the connected devices manually.

Note: Only in Access Point mode.

DHCP Client Table :

This DHCP Client Table shows client IP address assigned by the DHCP Server.

IP Address	MAC Address	Expiration Time
192.168.1.10	00:C0:9F:26:64:EE	Forever

Refresh

You can assign an IP address to the specific MAC address.

Enable Static DHCP IP

IP Address	MAC Address
192.168.1.100	80E3A39B703A

Add

Reset

Current Static DHCP Table :

NO.	IP Address	MAC Address	Select
1	192.168.1.50	00:24:E8:C7:41:0D	<input type="checkbox"/>

Delete Selected

Delete All

Reset

Apply

Cancel

The DHCP Client Table shows the LAN clients that have been allocated an IP address from the DHCP Server.

DHCP Client Table :

This DHCP Client Table shows client IP address assigned by the DHCP Server.

IP Address	MAC Address	Expiration Time
192.168.1.10	00:C0:9F:26:64:EE	Forever

Refresh

DHCP Client Table	
IP address	Displays the IP Address of the client on the LAN.
MAC address	Displays the MAC Address of the client on the LAN.
Expiration Time	Displays the time of expiration of the IP Address of the client.
Refresh	Click this button to update the DHCP Client Table.

4.4 Schedule

The **Schedule** option of the **System** menu allows you to set a schedule when the EAP300's Wireless is active.

The **Schedule Table** will display:

- **NO.:** The entry number of the schedule.
- **Description:** The name given to the schedule.
- **Service:** Displays whether the wireless service will be activate or not during the scheduled time.
- **Schedule:** Displays when the schedule will execute.

You will also be able to **Add** new schedules (at most 10), **Edit** schedules, **Delete Selected** schedules, or **Delete All** schedules.

Enabled Schedule Table (up to 10)

NO.	Description	Service	Schedule	Select
1	schedule 01	Wireless Active	From 11:00 To 12:00--- Mon, Wed	<input type="checkbox"/>

After selecting **Add** or **Edit**, the following form will show up. Fill in the form to set the schedule you want.

Schedule Description :	<input type="text" value="schedule 01"/>
Service :	<input checked="" type="checkbox"/> Wireless Active
Days :	<input type="checkbox"/> Every Day <input checked="" type="checkbox"/> Mon <input type="checkbox"/> Tue <input checked="" type="checkbox"/> Wed <input type="checkbox"/> Thu <input type="checkbox"/> Fri <input type="checkbox"/> Sat <input type="checkbox"/> Sun
Time of day :	<input type="checkbox"/> All Day (use 24-hour clock) From <input type="text" value="11"/> : <input type="text" value="0"/> To <input type="text" value="12"/> : <input type="text" value="0"/>
<input type="button" value="Apply"/> <input type="button" value="Cancel"/>	

Schedule	
Schedule Description	Assign a name to the schedule.
Service	The service provided for the schedule.
Days	Set which days the schedule will be active.
Time of day	Set what time of the selected days the schedule will be active.

4.5 Event Log

The **Event Log** of the **System** menu displays the system events and actions of the EAP300. When powered down or rebooted, the **Event Log** will be cleared.

View the system operation information.

```

day 1 00:00:07 [SYSTEM]: WLAN, start LLTD
day 1 00:00:06 [SYSTEM]: TELNETD, start Telnet-cli Server
day 1 00:00:06 [SYSTEM]: HTTPS, start
day 1 00:00:06 [SYSTEM]: HTTP, start
day 1 00:00:05 [SYSTEM]: UPnP, Start
day 1 00:00:05 [SYSTEM]: SNMP, start SNMP server
day 1 00:00:05 [SYSTEM]: SCHEDULE, Wireless Radio On
day 1 00:00:04 [SYSTEM]: NTP, start NTP Client
day 1 00:00:04 [SYSTEM]: DHCP, DHCP Server Stopping
day 1 00:00:03 [SYSTEM]: WLAN[2.4G], Channel = 11
day 1 00:00:03 [SYSTEM]: LAN, IP address=192.168.1.1
day 1 00:00:03 [SYSTEM]: LAN, start
day 1 00:00:01 [SYSTEM]: BR, start
day 1 00:00:01 [SYSTEM]: SYS, Application Version: 1.0.0
day 1 00:00:01 [SYSTEM]: Start Log Message Service!

```

Save Clear Refresh

Event Log	
Save	Save the log to a .txt file.
Clear	Clear the log.
Refresh	Update the log.

4.6 Monitor

The **Monitor** option of the **System** menu displays 2 histogram graphs. The histograms represent the bandwidth usage of both the daily use of the Ethernet and the daily use of the WLAN. If you click on **Detail**, a new browser window will open with 4 additional histograms (6 total). In the new browser window, you will be able to view the weekly and monthly bandwidth usage for both the Ethernet and WLAN.

Ethernet Daily Graph (5 Minute Average)

[Detail](#)

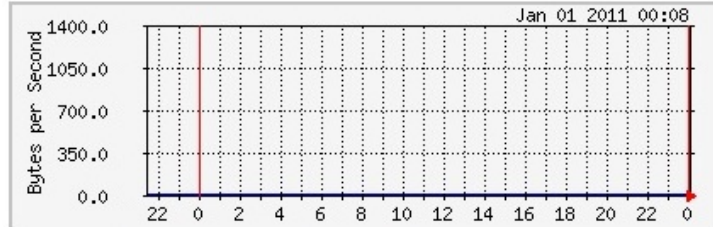

	Maximum	Average	Current
RX	293 B/sec	293 B/sec	293 B/sec
TX	1365 B/sec	1365 B/sec	1365 B/sec

WLAN Daily Graph (5 Minute Average)

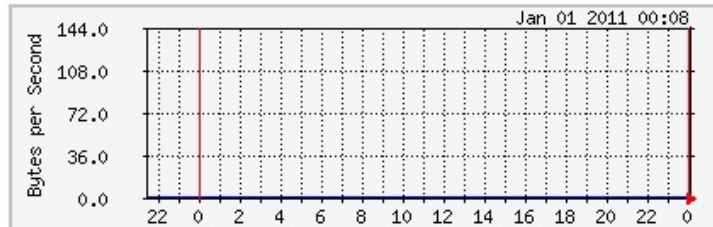

	Maximum	Average	Current
RX	0 B/sec	0 B/sec	0 B/sec
TX	144 B/sec	144 B/sec	144 B/sec

5 Wireless

5.1 Status

The **Status** of the **Wireless** menu displays the current status of the EAP300's wireless configuration.

View the current wireless connection status and related information.

WLAN Settings	
Channel	11
SSID_1	
ESSID	EnGeniusCC3004
Security	Disable
BSSID	00:AA:BB:CC:30:04

WLAN Settings	
Channel	The wireless channel in use.
ESSID	The SSID (Network Name) of the wireless network (up to 4 different SSIDs).
Security	Wireless encryption type that is used for the corresponding SSID.
BSSID	The MAC address of the corresponding SSID.

5.2 Basic

The **Basic** option of the **Wireless** menu displays the basic wireless options of the EAP300.

This page allows you to define Mode, Band, Multiple ESSID. You can also set up a static wireless channel or make Wireless device move to a clean Wireless Channel automatically.

Radio : Enable Disable

Mode :

Band :

Enabled SSID#:

ESSID1 :

Auto Channel: Enable Disable

Channel :

Basic	
Radio	Enable or Disable the EAP300's wireless signal.
Mode	Select between Access Point or Wireless Distribution System (WDS) modes.
Band	Select the types of wireless clients that the device will accept.
Enable SSID#	Select the number of SSID's (Wireless Network names) you would like (up to 4).
SSID#	Enter the name of your wireless network. You can use up to 32 characters.
Auto Channel	When enabled, the device will scan the wireless signals around your area and select the channel with the least interference.

Channel	Manually select which channel the wireless signal will use.
Check Channel Time	When Auto Channel is Enabled , you can specify the period of device will scan the wireless signals around your area.

Wireless Distribution System (WDS)

Using a WDS to connect Access Points wirelessly extends a wired infrastructure to locations where cabling is not possible or inefficient to implement.

Note: Compatibility between different brands and models of Access Points is not guaranteed. It is recommended that a WDS network be created using the same Access Point models for maximum compatibility.

Also, all Access Points in the WDS network need to use the same Channel and Security settings.

To create a WDS network, please enter the MAC addresses of the Access Points that you want included in the WDS. There can be a maximum of four access points.

Radio : Enable Disable

Mode : WDS ▾

Band : 2.4 GHz (B+G+N) ▾

Channel : 11 ▾

MAC Address 1 : 000000000000

MAC Address 2 : 000000000000

MAC Address 3 : 000000000000

MAC Address 4 : 000000000000

WDS Data Rate : 300M ▾

Set Security : Set Security

5.3 Advanced

The **Advanced** option of the **Wireless** menu displays the advanced wireless options of the EAP300.

It is recommended that the EAP300's default settings are used unless the user has experience with advanced networking.

These settings are only for expert user who is familiar with Wireless LAN procedure. Do not change these settings unless you know what effect the changes will have on your AP. Incorrect settings might reduce wireless performance.

Fragment Threshold :	<input type="text" value="2346"/> (256-2346)
RTS Threshold :	<input type="text" value="2347"/> (1-2347)
Beacon Interval :	<input type="text" value="100"/> (20-1024 ms)
DTIM Period :	<input type="text" value="1"/> (1-255)
N Data Rate:	Auto ▾
Channel Bandwidth	<input checked="" type="radio"/> Auto 20/40 MHz <input type="radio"/> 20 MHz
Preamble Type :	<input type="radio"/> Long Preamble <input checked="" type="radio"/> Short Preamble
CTS Protection :	<input checked="" type="radio"/> Auto <input type="radio"/> Always <input type="radio"/> None
Tx Power :	100 % ▾

Advanced (Access Point / WDS AP mode)

Fragment Threshold	Specifies the maximum size of the packet per fragment. This function can reduce the chance of packet collision. However, when the fragment threshold is set too low, there will be increased overhead resulting in poor performance.
---------------------------	---

RTS Threshold	When the packet size is smaller than the RTS Threshold, the packet will be sent without an RTS/CTS handshake, which may result in incorrect transmission.
Beacon Interval	The time interval that the device broadcasts a beacon. This beacon is used to synchronize all wireless clients on the network.
DTIM Period	A Delivery Traffic Indication Message (DTIM) informs all wireless clients that the access point will be transmitting Multi-casted data.
N Data Rate	You can limit the transfer rates between the device and wireless clients. Each Modulation Coding Scheme (MCS) refers to a specific transfer speed.
Channel Bandwidth	Set whether each channel uses 20Mhz or 40Mhz transmission frequency. To achieve 11n speeds, 40Mhz channels must be used.
Preamble Type	A preamble is a message that helps access points synchronize with the client. Long Preamble is standard based so increases compatibility. Short Preamble is non-standard, resulting in decreased compatibility, but increased performance.
Tx Power	Set the power output of the wireless signal.

These settings are only for expert user who is familiar with Wireless LAN procedure. Do not change these settings unless you know what effect the changes will have on your AP. Incorrect settings might reduce wireless performance.

Fragment Threshold :	<input type="text" value="2346"/>	(256-2346)
RTS Threshold :	<input type="text" value="2347"/>	(1-2347)
N Data Rate:	Auto ▾	
Channel Bandwidth	<input checked="" type="radio"/> Auto 20/40 MHz <input type="radio"/> 20 MHz	
Preamble Type :	<input type="radio"/> Long Preamble <input checked="" type="radio"/> Short Preamble	
CTS Protection :	<input checked="" type="radio"/> Auto <input type="radio"/> Always <input type="radio"/> None	
Tx Power :	100 % ▾	

Apply Cancel

Advanced (WDS Bridge mode)	
Fragment Threshold	Specifies the maximum size of the packet per fragment. This function can reduce the chance of packet collision. However, when the fragment threshold is set too low, there will be increased overhead resulting in poor performance.
RTS Threshold	When the packet size is smaller than the RTS Threshold, the packet will be sent without an RTS/CTS handshake, which may result in incorrect transmission.
N Data Rate	You can limit the transfer rates between the device and wireless clients. Each Modulation Coding Scheme (MCS) refers to a specific transfer speed.
Channel Bandwidth	Set whether each channel uses 20Mhz or 40Mhz transmission frequency. To achieve 11n speeds, 40Mhz channels must be used.

Preamble Type	A preamble is a message that helps access points synchronize with the client. Long Preamble is standard based so increases compatibility. Short Preamble is non-standard, resulting in decreased compatibility, but increased performance.
Tx Power	Set the power output of the wireless signal.

5.4 Security

The **Security** option in the **Wireless** menu allows you to set the wireless security settings.

Note: Only in Access Point and WDS AP mode.

This page allows you setup the wireless security. You can turn on WEP or WPA by using Encryption Keys, besides you can enable 802.1x Authentication or RADIUS to coordinate with RADIUS server.

ESSID Selection : EnGeniusCC3004 ▾
Separate : SSID STA
Broadcast ESSID : Enable ▾
WMM : Enable ▾
Encryption : Disable ▾
 Enable 802.1x Authentication

Disable
 Disable
 WEP
 WPA pre-shared key
 WPA RADIUS

Security (Access Point / WDS AP mode)	
SSID Selection	Select the SSID that the corresponding security settings will apply to.
Separate	Separating the SSID from each other (or use of STA) prevents communication and data sharing between wireless stations associated with the SSIDs.
Broadcast SSID	If Disabled , the EAP300 will not broadcast the SSID. It will be invisible to the clients.
WMM	Wi-Fi Multi-Media is a Quality of Service protocol which prioritizes traffic in the order according to voice, video, best effort, and background. Note: In certain situations, WMM needs to be enabled to achieve 11n transfer speeds.

Encryption	<p>The encryption method to be used on the corresponding SSID. You can choose between WEP, WPA Pre-Shared Key, or WPA RADIUS.</p> <ul style="list-style-type: none"> • Disabled - No data encryption is used. • WEP - Data is encrypted using the WEP standard. WEP is the Wired Equivalent Privacy security over a wireless network. • WPA-PSK - Data is encrypted using the WPA-PSK standard. This is a later standard than WEP, and provides much better security than WEP. WPA-PSK is Wi-Fi Protected Access using a Pre-Shared Key. This is the equivalent of password protecting your wireless network. • WPA2-PSK - This is a further development of WPA-PSK, and offers even greater security, using the AES (Advanced Encryption Standard) method of encryption. • WPA-RADIUS - This version of WPA requires a Radius Server on your LAN to provide the client authentication according to the 802.1x standard. Data transmissions are encrypted using the WPA standard. <p>If this option is selected:</p> <ul style="list-style-type: none"> • This Access Point must have a Client Login on the Radius Server. • Each user must have a User Login on the Radius Server. • Each user's wireless client must support 802.1x and provide the login data when required. • All data transmission is encrypted using the WPA standard. Keys are automatically generated, so no key input is required.
-------------------	--

IEEE 802.1x is an authentication protocol. Every user must use a valid account to login to this Access Point before accessing the wireless LAN. The authentication is then processed by a RADIUS server. This mode only authenticates users by IEEE 802.1x, but it does not encrypt the data during communication.

Enable 802.1x Authentication

RADIUS Server IP Address :

RADIUS Server Port :

RADIUS Server Shared Secret :

802.1x Authentication	
RADIUS Server IP Address	The IP Address of the RADIUS Server.
RADIUS Server port	The port number of the RADIUS Server.
RADIUS Server password	The RADIUS Server password.

WEP Encryption:

Encryption :	WEP ▾
Authentication Type :	<input checked="" type="radio"/> Open System <input type="radio"/> Shared Key <input type="radio"/> Auto
Key Length :	64-bit ▾
Key Type :	Hex (10 characters) ▾
Default Key :	Key 1 ▾
Encryption Key 1 :	1234567890
Encryption Key 2 :	
Encryption Key 3 :	
Encryption Key 4 :	

WEP Encryption	
Authentication Type	Please ensure that your wireless clients use the same authentication type.
Key type	ASCII: Using characters from the ASCII standard (recommended) HEX: Uses hexadecimal characters.
Key Length	The amount of bits the WEP key will use. <ul style="list-style-type: none"> • 64 Bit - data is encrypted, using the default key, before being transmitted. You must enter at least the default key. For 64 Bit Encryption, the key size is 10 chars in HEX (0~9 and A~F). • 128 Bit - data is encrypted, using the default key, before being transmitted. You must enter at least the default key. For 128 Bit Encryption, the key size is 26 chars in HEX (0~9 and A~F).
Default Key	Select the key you wish to be the default. Transmitted data is ALWAYS encrypted using the Default Key; the other Keys are for decryption only. You must enter a Key Value for the Default Key .
Encryption Key #	Enter the key value or values you wish to use. Only the Key selected as Default is required. The others are optional.

WPA Pre-Shared Key Encryption:

Encryption :	WPA pre-shared key ▾
WPA Type :	<input type="radio"/> WPA(TKIP) <input type="radio"/> WPA2(AES) <input checked="" type="radio"/> WPA2 Mixed
Pre-shared Key Type :	Passphrase ▾
Pre-shared Key :	12345678

WPA Pre-Shared Key Encryption	
WPA type	Select the WPA encryption you would like. Please ensure that your wireless clients use the same settings. <ul style="list-style-type: none"> • WPA(TKIP): Uses a Pre-Shared Key with a dynamically generated key for each 128-bit packet. • WPA2(AES): Government standard of WPA2 encryption. • WPA2 Mixed: Allows the use of both WPA and WPA2 clients on the network.
Pre-shared Key Type	Pre-Shared Key format (ASCII or Hexadecimal).
Pre-shared Key	Wireless clients must use the same key to associate the device to the EAP300. If using passphrase format, the Key must be from 8 to 63 characters in length.

WPA RADIUS Encryption:

Encryption :	WPA RADIUS ▾
WPA Type :	<input type="radio"/> WPA(TKIP) <input type="radio"/> WPA2(AES) <input checked="" type="radio"/> WPA2 Mixed
RADIUS Server IP Address :	<input type="text"/>
RADIUS Server Port :	<input type="text" value="1812"/>
RADIUS Server Shared Secret :	<input type="text"/>

WPA RADIUS Encryption	
WPA type	<p>Select the WPA encryption you would like. Please ensure that your wireless clients use the same settings.</p> <ul style="list-style-type: none"> • WPA(TKIP): Uses a Pre-Shared Key with a dynamically generated key for each 128-bit packet. • WPA2(AES): Government standard of WPA2 encryption. <p>WPA2 Mixed: Allows the use of both WPA and WPA2 clients on the network.</p>
RADIUS Server IP address	Enter the IP address of the RADIUS Server.
RADIUS Server Port	Enter the port number used for connections to the RADIUS server.
RADIUS Server password	Enter the password required to connect to the RADIUS server.

5.5 Filter

The **Filter** option in the **Wireless** menu allows users to allow clients with specific MAC Addresses to join the SSID.

Note: Only in Access Point and WDS AP mode.

Using MAC Address Filtering could prevent unauthorized MAC Address to associate with the AP.

Enable Wireless MAC Filtering

Description	MAC Address
rule02	80A49E837BA2

Add Reset

Only the following MAC Addresses can use network:

NO.	Description	MAC Address	Select
1	rule01	00:21:6A:78:8E:70	<input type="checkbox"/>

Delete Selected Delete All Reset

Apply Cancel

Wireless Filter (Access Point / WDS AP mode)	
Enable Wireless Access Control	Enable Wireless Access Control. When Enabled, only wireless clients on the Filtering Table will be allowed.
Description	Enter a name or description for this entry.

MAC address	Enter the MAC address of the wireless client that you wish to allow connection.
Add	Click this button to add the entry.
Reset	Click this button if you have made a mistake and want to reset the MAC address and Description fields.
MAC Address Filtering Table	
Only clients listed in this table will be allowed access to the wireless network.	
Delete Selected	Delete the selected entries.
Delete All	Delete all entries.
Reset	Deselect all entries.

5.6 WPS (Wi-Fi Protected Setup)

The **WPS** feature in the **Wireless** menu follows the Wi-Fi Alliance WPS standard. It eases the set up of security-enabled Wi-Fi networks in homes and/or small office environments.

It reduces the user steps required to configure a network and supports two methods that are familiar to most consumers to configure a network and enable security.

Note: Only in Access Point and WDS AP mode.

WPS: Enable

Wi-Fi Protected Setup Information

WPS Current Status: Configured

Self Pin Code: 33816364

SSID: EnGeniusCC3004

Authentication Mode: WPA/WPA2 pre-shared key

Passphrase Key :

WPS Via Push Button:

WPS Via PIN:

Wi-Fi Protected Setup (WPS)	
WPS	Check to Enable the WPS feature.
Wi-Fi Protected Setup Information	
WPS Current Status	Shows whether the WPS function is Configured or Un-configured . Configured means that WPS has been used to authorize connection between the EAP300 and the wireless clients.
SSID	The SSID (network name) used when connecting using WPS.

Authentication Mode	Shows the encryption method used by the WPS process. This is set as the mode selected in the Security option in the Wireless menu.
Passphrase Key	This is the passphrase key that is randomly generated during the WPS process. It is required if wireless clients that do not support WPS attempts to connect to the wireless network.
WPS Via Push Button	Activate WPS using a push button.
WPS Via PIN	Activate WPS using the PIN code from the WPS device.

5.7 Client List

The **Client List** option of the **Wireless** menu shows all the wireless clients that are currently connected to the EAP300.

Note: Only in Access Point and WDS AP mode.

WLAN Client Table :

This WLAN Client Table shows client MAC address associate to this device.

Interface	MAC Address	Rx	Tx	Signal(%)	Connected Time	Idle Time
EnGeniusCC3004	00:02:6F:11:AC:93	1852677	1832060	44	10 min 27 secs	0 secs
EnGeniusCC3004	00:02:6F:47:65:CA	1519236	1493659	36	6 min 50 secs	0 secs

Refresh

5.8 VLAN

The **VLAN** option of the **Wireless** menu allows you to configure the VLAN (Virtual LAN).

Note: Only in Access Point and WDS AP mode.

A virtual LAN, commonly known as a VLAN, is a group of hosts with a common set of requirements that communicate as if they were attached to the same wire, regardless of their physical location.

Virtual LAN : Enable Disable

SSID 1 Tag: (1~4094)

LAN VLAN MGMT : Enable Disable

MGMT Tag: (1~4094)

VLAN	
Virtual LAN	Choose to Enable or Disable the VLAN feature.
SSID# Tag	Specify the VLAN tag for each SSID.
LAN VLAN MGMT	Choose to Enable or Disable the LAN VLAN MGMT feature.
MGMT Tag	Specify the VLAN tag for the LAN.

6 Network

6.1 Status

The **Status** option of the **Network** menu shows the current status of the EAP300's LAN connection.

LAN Settings

IP Address	192.168.1.1
Subnet Mask	255.255.255.0
Gateway IP Address	---
MAC Address	00:AA:BB:CC:30:04

6.2 LAN

The **LAN** option of the **Network** menu allows you to modify the device's LAN settings.

Bridge Type :	Static IP ▾
IP Address :	192.168.1.1
IP Subnet Mask :	255.255.255.0
Default Gateway :	
DNS Type :	Static ▾
First DNS Address :	192.168.1.1
Second DNS Address :	192.168.1.1

LAN IP	
Bridge Type	Select the Bridge type of the LAN. Static IP: Manually specify an IP address and subnet mask for the EAP300 to use. Dynamic IP: The IP address is received automatically from the external DHCP server.
IP address	The LAN IP Address of the EAP300.
IP Subnet Mask	The LAN Subnet Mask of the EAP300.
Default Gateway	The Default Gateway of the EAP300. Leave empty for default setting.
DNS Type	Select the DNS type of the LAN. Static DNS: Manually specify the DNS of the EAP300. Dynamic DNS: The DNS is received automatically from the external DNS server.
First / Second DNS Address	The first / second DNS address for this device.

The **DHCP Server** feature is only available in Access Point mode.

DHCP Server

DHCP Server :	Disabled ▾
Lease Time :	Forever ▾
Start IP :	192.168.1.100
End IP :	192.168.1.200
Domain Name :	eap300
First DNS Address :	
Second DNS Address :	

DHCP Server (Access Point mode)	
DHCP Server	Enable or disable DHCP feature. The DHCP Server automatically allocates IP addresses to your LAN device. Disabled as default.
Lease Time	The duration of the DHCP server allocates each IP address to a LAN device.
Start / End IP	The range of IP addresses of the DHCP server will allocate to LAN device.
Domain name	The domain name for this LAN network.
First / Second DNS Address	The first / second DNS address for this LAN network.

6.3 Spanning Tree

The **Spanning Tree** option of the **Network** menu allows you to set the EAP300 to use the Spanning Tree Protocol. Enabling Spanning Tree Protocol will prevent network loops in your LAN network.

Spanning Tree Settings

Spanning Tree Status :	<input type="radio"/> Enable <input checked="" type="radio"/> Disable
Bridge Hello Time :	<input type="text" value="2"/> seconds (1-10)
Bridge Max Age :	<input type="text" value="20"/> seconds (6-40)
Bridge Forward Delay :	<input type="text" value="15"/> seconds (4-30)
Bridge Priority :	<input type="text" value="32768"/> (0-65535)

Spanning Tree Settings	
Spanning Tree Status	Enable or disable the Spanning Tree Protocol.
Bridge Hello Time	The duration of the initial connection between two access points.
Bridge Max Age	The maximum amount of time the bridge is connected when transmitting.
Bridge Forward Delay	The delay between transmissions between access points.
Bridge Priority	The priority port of the Spanning Tree Protocol.

7 Management

7.1 Admin

The **Admin** section of the **Management** menu allows you to change the EAP300 default password and to configure remote management. By default, the password is: **admin**. The password can contain 0 to 12 alphanumeric characters and is case sensitive.

You can change the password that you use to access the device, this is not you ISP account password.

Old Password :	<input type="text"/>
New Password :	<input type="text"/>
Confirm password :	<input type="text"/>
Idle Timeout :	<input type="text" value="10"/> (1~10 Minutes)

Change Password	
Old Password	Enter the current password.
New Password	Enter your new password.
Confirm Password	Reenter your new password.
Idle Timeout	Enter Administration Page timeout time (minutes).

7.2 SNMP

The **SNMP** section of the **Management** menu allows you to assign the contact details, location, community name, and trap settings for the Simple Network Management Protocol (SNMP). The SNMP is a networking management protocol used to monitor network-attached devices. SNMP allows messages (called protocol data units) to be sent to various parts of a network. Upon receiving these messages, SNMP-compatible devices (Agents) return data stored in their Management Information Bases.

SNMP is used in network management systems to monitor network-attached devices for conditions that warrant administrative attention.

SNMP Active	Disabled ▾
SNMP Version	All ▾
SNMP Manager IP	0.0.0.0
Read Community	public
Set Community	private
System Location	EnGenius Technologies, Inc.
System Contact	SENAO Networks, Inc.
Trap Active	Disabled ▾
Trap Manager IP	192.168.1.100
Trap Community	public

SNMP	
SNMP Active	Enable or disable the SNMP feature.
SNMP Version	You may select the SNMP version you want to deploy. All: Interoperability between SNMPv1 and SNMPv2c devices. v1: The standard SNMP version. v2c: Improvement in performance and security of SNMPv1.
Read Community	Specify the password for access the SNMP community for read only access.
Set Community	Specify the password for access to the SNMP community with read/write access.
System Location	Specify the location of the device.
System Contact	Specify the contact details of the device
Trap	
Trap Active	Enable or disable SNMP trapping feature.
Trap Manager IP	Specify the IP address of the computer that will receive the SNMP traps.
Trap Community	Specify the password for the SNMP trap community.

7.3 Firmware Upgrade

The **Firmware Upgrade** section of the **Management** allows you to upgrade the EAP300's firmware.

You can upgrade the firmware of the device in this page. Ensure, the firmware you want to use is on the local hard drive of your computer. Click on Browse to browse and locate the firmware to be used for your update.

To perform the Firmware Upgrade:

1. Download the firmware version that you want to install into the EAP300 and place it in a known location.
2. Click the **Browse** button and navigate to the location of the firmware upgrade file.
3. Select the firmware upgrade file. Its name will appear in the **Upgrade File** field.
4. Click the **Apply** button to commence the firmware upgrade.

Note: The device is unavailable during the upgrade process, and must restart when the upgrade is completed. Any connections to or through the device will be lost.

Emergency Upgrade

If your firmware upgrade failed, you may enter the Emergency Upgrade WEB page.

1. Enter IP address: **192.168.99.9** and enter Emergency Upgrade WEB page.



Note: Refer to 2.2 to configure PC/Notebook IP address to 192.168.99.8.

2. Click the **Browse** button and navigate to the location of the upgrade file and then click **Upload**.

Emergency Web Server

File

3. Wait for 60 seconds for firmware upgrade and reboot the device.

Updating File.....

Don't Power Down.

Please wait for **58** seconds ...

4. You can access the device again.



The image shows a login dialog box for EnGenius. It has a title bar with the text "EnGenius". Below the title bar, there are two input fields. The first is labeled "Username:" and contains the text "admin". The second is labeled "Password:" and contains five black dots. Below the input fields, there are two buttons: "Login" and "Cancel".

7.4 Configure

The **Configure** option of the **Management** menu allows you to save the current device configurations. When you save the configurations, you also can re-load the saved configurations into the device through the **Restore Settings**. If extreme problems occur press the **Reset** button of the **Restore to Factory Defaults** option to set all configurations to its original default settings.

The current system settings can be saved as a file onto the local hard drive. The saved file can be loaded back on the device. To reload a system settings file, click on BROWSE to locate the system file to be used. You may also reset the device back to factory default settings by clicking RESET.

Restore To Factory Default :	<input type="button" value="Reset"/>
Backup Settings :	<input type="button" value="Save"/>
Restore Settings :	<input type="text"/> <input type="button" value="Browse..."/> <input type="button" value="Upload"/>

Configure	
Restore to Factory Default	Restores the device to factory default settings.
Backup Settings	Save the current configuration settings to a file.
Restore Settings	Restores a previously saved configuration file. Click Browse to select the file. Then Upload to load the settings.

7.5 Reset

In some circumstances it may be required to force the device to reboot. Click on **Apply** to reboot of the **Reset** option of the **Management** menu.

In the event the system stops responding correctly or stops functioning, you can perform a reset. Your settings will not be changed. To perform the reset, click on the APPLY button. You will be asked to confirm your decision. The reset will be completed when the LED Power light stops blinking.

Apply

8 Tools

8.1 Time Setting

The **Time Setting** section of the **Tools** menu allows you to set the EAP300's time.

The device reads the correct time from NTP servers on the Internet and sets its system clock accordingly. The Daylight Savings option merely advances the system clock by one hour. The time zone setting is used by the system clock when displaying the correct time in schedule and the log files.

Time Setup :	Synchronize with the NTP Server ▾
Time Zone :	(GMT)Greenwich Mean Time: Dublin, Edinburgh, Lisbon, London ▾
NTP Time Server :	<input type="text"/>
Daylight Saving :	<input type="checkbox"/> Enable From <input type="text" value="January"/> <input type="text" value="1"/> To <input type="text" value="January"/> <input type="text" value="1"/>

Time	
Time Setup	Select the method you want to set the time.
Time Zone	Select the time zone for your current location.
NTP Time Server	Enter the address of the Network Time Protocol (NTP) Server to automatically synchronize with a server on the Internet.
Daylight Savings	Check whether daylight savings applies to your area.

8.2 Diagnosis

The **Diagnosis** section of the **Tools** menu allows you to test your network. Type in the IP Address of the device for diagnosis.

This page can diagnose the current network status.

Address to Ping :	<input type="text"/>
Ping Frequency :	<input type="text" value="1"/> <input type="button" value="Start"/>

Diagnosis	
Address to Ping	Enter the IP address you like to see if a successful connection can be made.
Ping Frequency	Select the frequency for Ping test.
Ping Result	The results of the Ping test.

8.3 LED Control

The **LED Control** section of the **Tools** menu allows you switch on or off the LED (lights) for Power, LAN interface, and WLAN interface of the EAP300.

You can use the LED control page to control LED on/off for Power, LAN interface and WLAN interface.

LED Control :

Power LED : On Off

LAN LED : On Off

WLAN LED : On Off

Apply

Cancel

9 Logout

Click on **Logout** button to logout of the EAP300.

This page is used to logout this device.

Logout

Appendix A – FCC Interference Statement

Federal Communication Commission Interference Statement

This equipment has been tested and found to comply with the limits for a Class B digital device, pursuant to Part 15 of the FCC Rules. These limits are designed to provide reasonable protection against harmful interference in a residential installation. This equipment generates uses and can radiate radio frequency energy and, if not installed and used in accordance with the instructions, may cause harmful interference to radio communications. However, there is no guarantee that interference will not occur in a particular installation. If this equipment does cause harmful interference to radio or television reception, which can be determined by turning the equipment off and on, the user is encouraged to try to correct the interference by one of the following measures:

- Reorient or relocate the receiving antenna.
- Increase the separation between the equipment and receiver.
- Connect the equipment into an outlet on a circuit different from that to which the receiver is connected.
- Consult the dealer or an experienced radio/TV technician for help.

FCC Caution: Any changes or modifications not expressly approved by the party responsible for compliance could void the user's authority to operate this equipment.

This device complies with Part 15 of the FCC Rules. Operation is subject to the following two conditions: (1) This device may not cause harmful interference, and (2) this device must accept any interference received, including interference that may cause undesired operation.

IMPORTANT NOTE:

FCC Radiation Exposure Statement:

This equipment complies with FCC radiation exposure limits set forth for an uncontrolled environment.

This device complies with FCC RF Exposure limits set forth for an uncontrolled environment, under 47 CFR 2.1093 paragraph (d)(2).

This transmitter must not be co-located or operating in conjunction with any other antenna or transmitter.