

Quick Installation Guide

TL-SC3171
Day/Night Surveillance Camera
TL-SC3171G
Wireless Day/Night Surveillance Camera

1 Package Contents

Note: The product model shown in this QIG is TL-SC3171G, as an example.

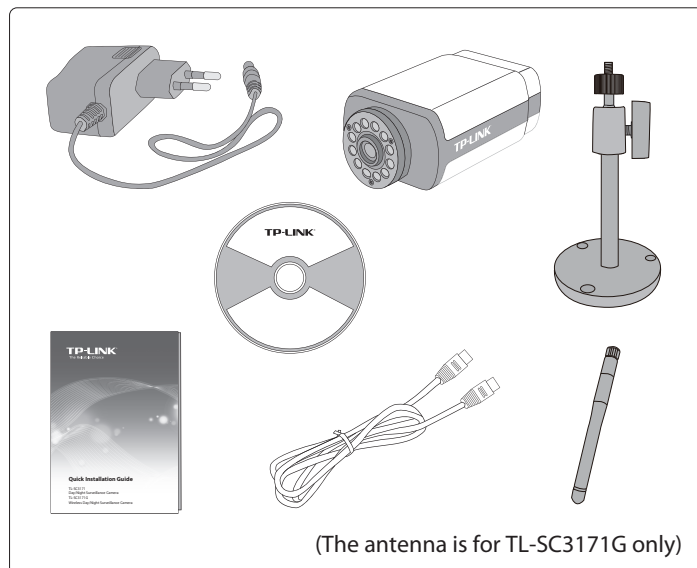

System Requirement

The following operating systems are supported:

- Windows XP
- Windows Vista
- Windows 7
- Windows 98
- Windows 2000
- Windows 2003
- Windows Me
- Mac
- Linux

The following browser are supported:

- Microsoft Internet Explorer
- FireFox
- Safari
- Chrome

7106503246

2 Warning Before Installation

- Do not keep the Camera exposed to direct sunlight

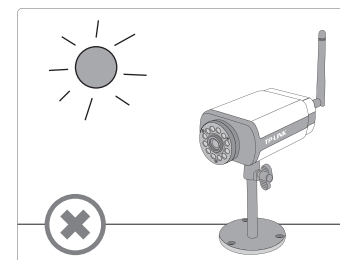

- Do not place the camera near devices that emit radio waves, such as mobile phones

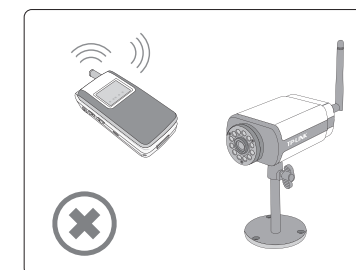

- Do not place the Camera in high humidity environments such as a kitchen

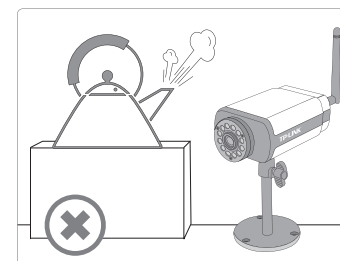

- Do not place the Camera where are sharp temperature such as an oven

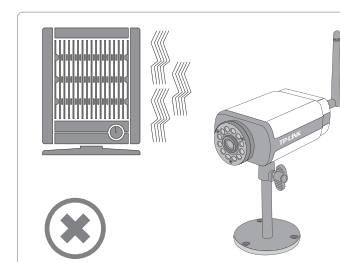

- We recommend to mount the camera where objects often pass the camera from the sides, and the camera towards the door or passage is much better, see the illustration below:

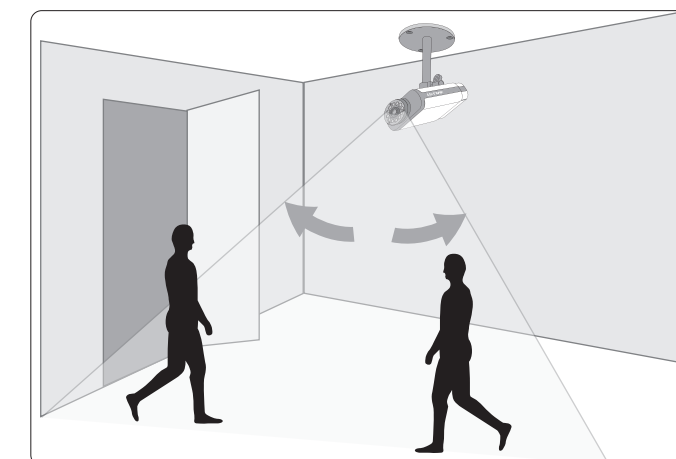

3 Physical Description

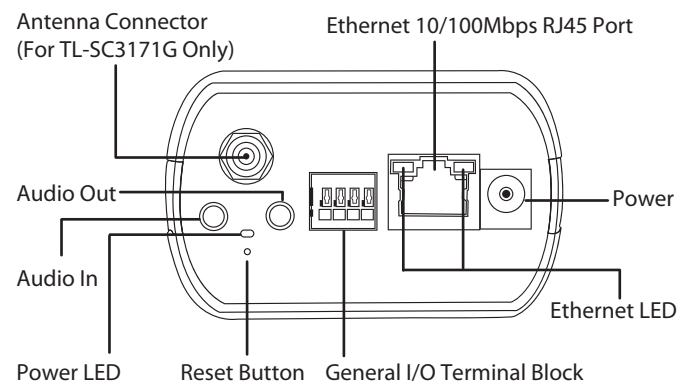

Item	Description
Power LED	<ul style="list-style-type: none"> Solid. The electrical power is on. Off. There is no electrical power.
Ethernet LED	<ul style="list-style-type: none"> Solid. The Ethernet port is linked, but there is no activity. Blinking. There is traffic between the Ethernet port and the network. Off. There is no Ethernet connection.

4 Hardware Connection

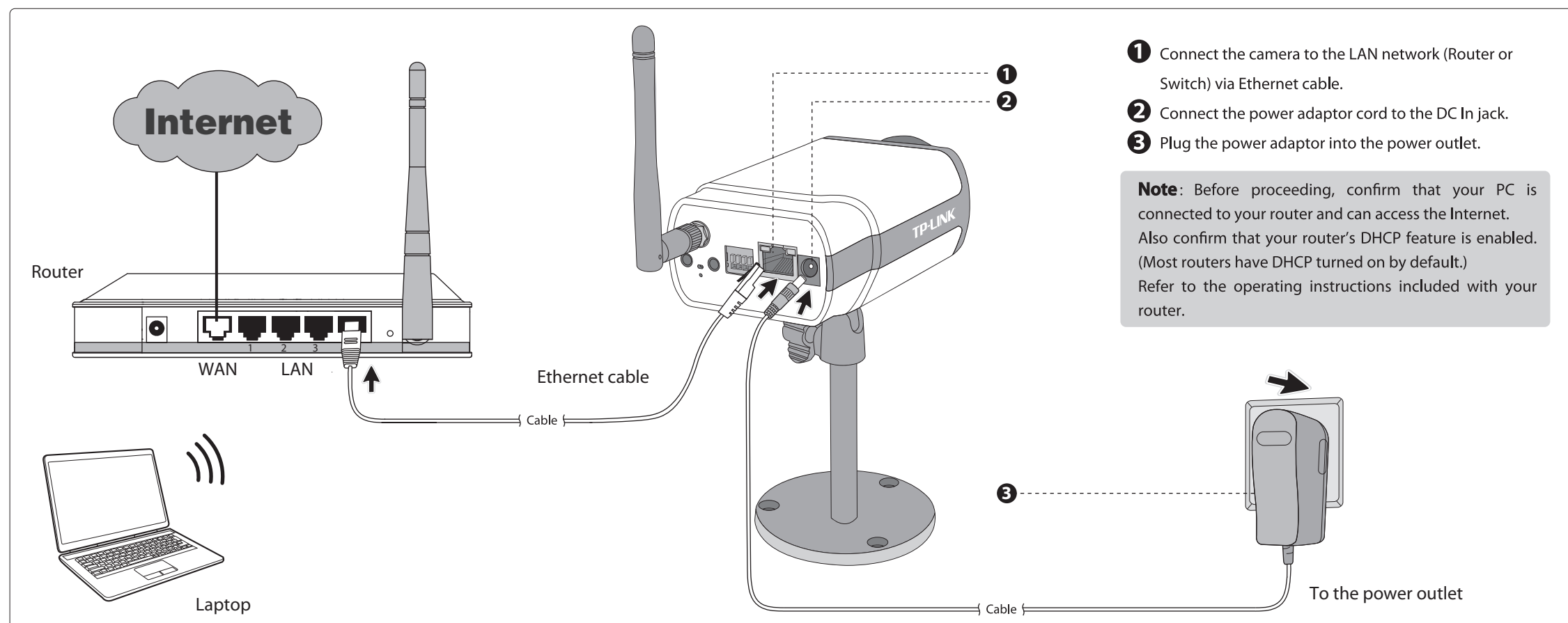

5 PC Configuration

We take IE in Windows XP for example, it is similar in Windows Vista/Windows 7.

- 1 Open IE browser. Click "Tools", then "Internet Options...".

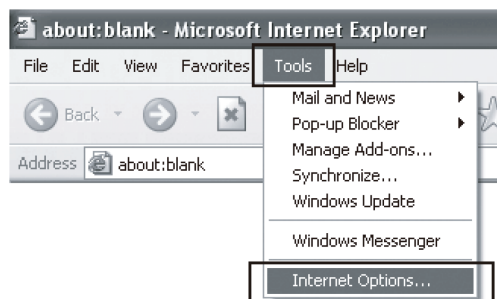

- 2 Click "Security" -> "Internet" -> "Custom Level...". Find the item "Download signed ActiveX controls" and make sure it is "Prompt", then Click "OK".

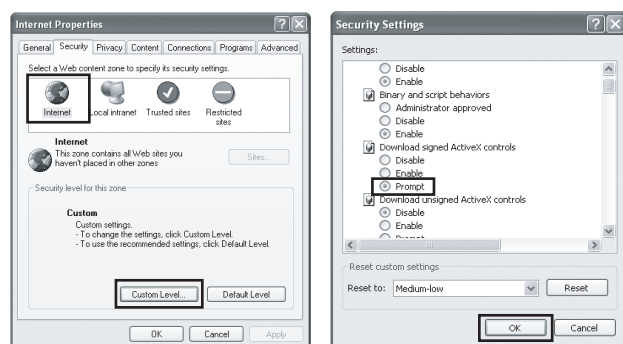

- 3 Click "Security" -> "Local Intranet" -> "Custom Level...". Find the item "Download signed ActiveX controls" and make sure it is "Prompt", then Click "OK".

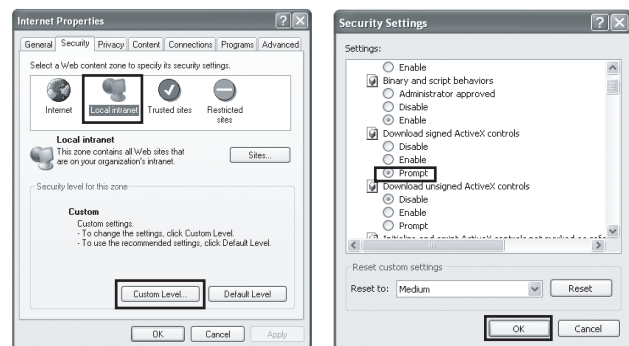

6 Software Installation

- 1 Insert the provided Resource CD into your CD-ROM drive.

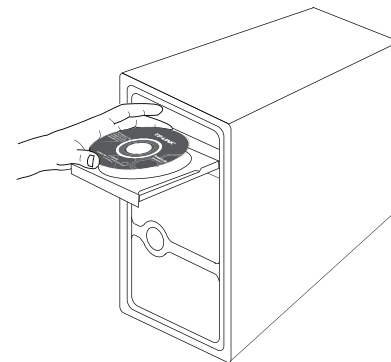

- 2 The Setup Wizard will automatically pop up on your computer's screen, then click "Intelligent IP Installer" (you can click the installer's manual later for advanced setting guide)?



- 3 The Intelligent IP Installer window will appear. Please click on the "Next" button to continue the program.

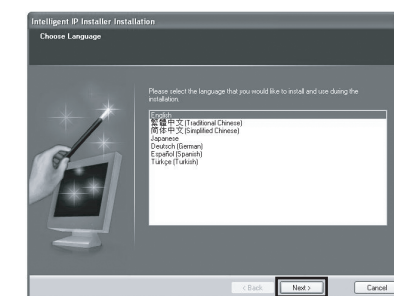

- 4 Select the optional program including our innovative MSN Function, TP-LINK strongly recommends that you choose it by default. Click "Next".

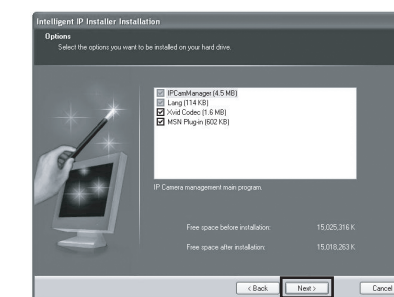

Setup is completed. Click "Finish".

7 Access the Camera using IP Installer

- 1 Click the Intelligent IP Installer icon on the computer's Desktop.



Then click the "Search", the main page will show up listing all active TP-LINK camera devices. Select the relevant camera from the list and click "Link to IE".

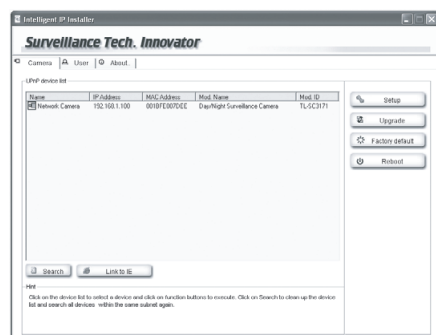

- 2 Enter your Username and Password to login to the IP Camera. (Default is admin / admin)



- 3 When accessing the IP Camera for the first time, a yellow information bar appears below the address bar, click the information bar, and select "Install ActiveX Control...".

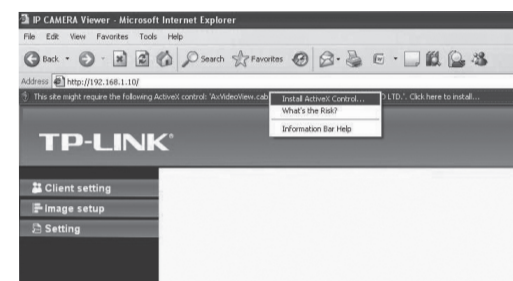

- 4 Click "Install".



- 5 Live video displays in the centre of your web browser.



Your surveillance Camera Installation is Complete!

1. The item "Download signed ActiveX controls" is "Prompt" by default, you can change it after the whole configuration.
2. If the CD does not automatically run with the installation window appearing, find the CD drive in the "My Computer" space and run it directly there.
3. A warning page will pop up automatically if the MSN program is not installed in your computer. You can reinstall the MSN Plug-in after the installation of the MSN.

Note: To configure wireless connection, MSN View and the other parameters, please refer to the TL-SC3130G's manual on resource CD. For more details about Troubleshooting and Technical Support contact information, please log on to our Technical Support Website.

<http://www.tp-link.com/support/Support.asp>

Technical Support

- For more troubleshooting help, go to www.tp-link.com/support/faq.asp
- To download the latest Firmware, Driver, Utility and User Guide, go to www.tp-link.com/support/download.asp
- For all other technical support, please contact us by using the following details:

Global
Service Language: English
Tel: +86 755 26504400
E-mail: support@tp-link.com
Service time: 24hrs, 7days a week

Australia & New Zealand
Tel: AU 1300 87 5465
NZ 0800 87 5465
E-mail: support@tp-link.com.au
Service time: Monday to Friday
9:00 AM to 9:00 PM AEST

Singapore
Tel: +65 62840493
E-mail: support.sg@tp-link.com
Service time: 24hrs, 7days a week

Germany / Austria / Switzerland
Tel: +49 1805 875465 (German Service)
E-mail: support.de@tp-link.com
Service time: Monday to Friday 9:00 AM to 6:00 PM, GMT+ 1 or GMT+ 2 (Daylight Saving Time in Germany)
Except bank holidays in Hesse

USA/Canada
Toll Free: +1 866 225 8139
E-mail: support.usa@tp-link.com
Service time: 24hrs, 7days a week

UK
Tel: +44 (0) 845 147 0017
E-mail: support.uk@tp-link.com
Service time: 24hrs, 7days a week

TP-LINK TECHNOLOGIES CO., LTD.
www.tp-link.com